

Material: PVC / PPs / PP / PE

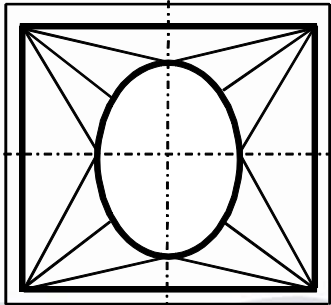
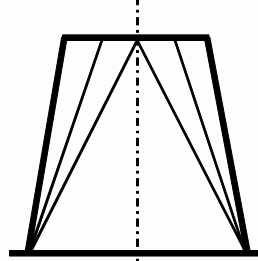
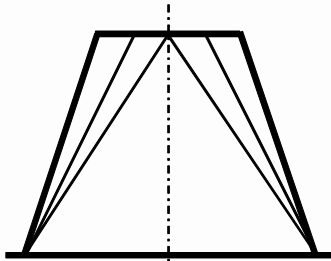

Anschlußmöglichkeiten:

Runde-Seite
Muffe, Rohr, glatt, Flansch

Eckige Seite
Muffe, Kanal, glatt, Flansch

Weitere Varianten (Draufsicht)

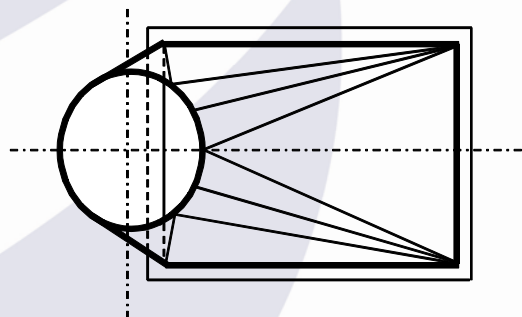
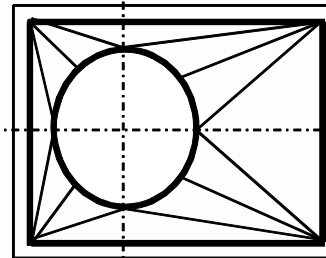
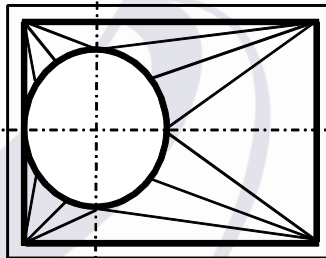
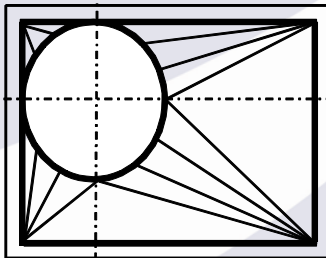

alle Maße in mm
Änderungen vorbehalten